



Get 2 years of free warranty



# PISTON COMPRESSOR PCAP200VT25

IN GOOD HANDS  
Original Instruction Manual

GB / SP / DE / PT





## WHO ARE WE?

Peugeot Professional Tools was born from several obvious reasons.

The idea was to bring together the know-how of Peugeot, which has mastered the art of cutting since 1810, and the expertise of Tivoly, a metalworker since 1917, in order to create a wide range of machines and tools for construction and maintenance professionals.

It is also the obvious desire to serve artisans and small businesses driven by strong family and heritage values.

For these professionals, Peugeot Professional Tools offers machines and tools specifically designed for their needs. Reliable, durable tools, repairable in France and in countries under distribution agreements by local industrial and family partners.

Reliable equipment, with a longer warranty, with logistics and a

French after-sales service. The assurance of dealing with the people who assembled these tools and know every part that makes them up inside and out.

From exceptional work to the everyday job site, these tools are designed to withstand the most demanding conditions and to be durable over time.

Peugeot Professional Tools was born from one final realization: that our tools are in good hands. The hands of those who work behind the scenes and give their all to satisfy their customers.

Since 1B1O, many things have changed, but the hands have remained the same. The hands of passionate enthusiasts, artisans, technicians, and dedicated installers, of workers proud of themselves and their achievements.

Peugeot Professional Tools, tools in good hands.

## THANK YOU FOR YOUR PURCHASE.

No one could ever tell you what you want to hear

ChOisiPeLgeOI Out PRO e siOinne

Ch ue dÓlailc OIOCONru DOurVOUs

mentary. For a good, beneficial, and re-  
registry - you on

[www.puegeot-outlet.com](http://www.puegeot-outlet.com)

rJCcr in Q er rJ ChcJ and and l rJ De And  
vOl re and it is said with la mark e

You will benefit from a guarantee  
of 2 years, extendable by 2 years on PP -



# Rolling Air Compressor, Cast Iron V-Twin Engine



## PCAP200VT25

Ref. : PPC00100004

### Features:

Intake flow	25 m <sup>3</sup> /h, or 417 l/min
Delivered flow	18.7 m <sup>3</sup> /h, or 313 l/min
Motor	3 HP, 3-Phase
Reservoir	200 liters
Pressure	10 bar max
Footprint	139 x 60 x 93 cm
Weight	91.6 kg
Acoustic power	94 dB (A) LWA

### Equipment:

- Regulator with quick-connect fitting: working pressure adjustment
- 16 bar pressure gauge: tank pressure indicator
- Circuit breaker
- Check valve, safety valve, drain valve
- Handle for handling
- Large diameter wheels Ø 220 mm
- Front steering wheel

You have just purchased a Peugeot Outils Professionnels air compressor, and we thank you for your trust.

To get the most out of your compressor safely, please read this manual carefully before installation, use, and any maintenance.

# PCAP200VT25

## Specifications:

Front view

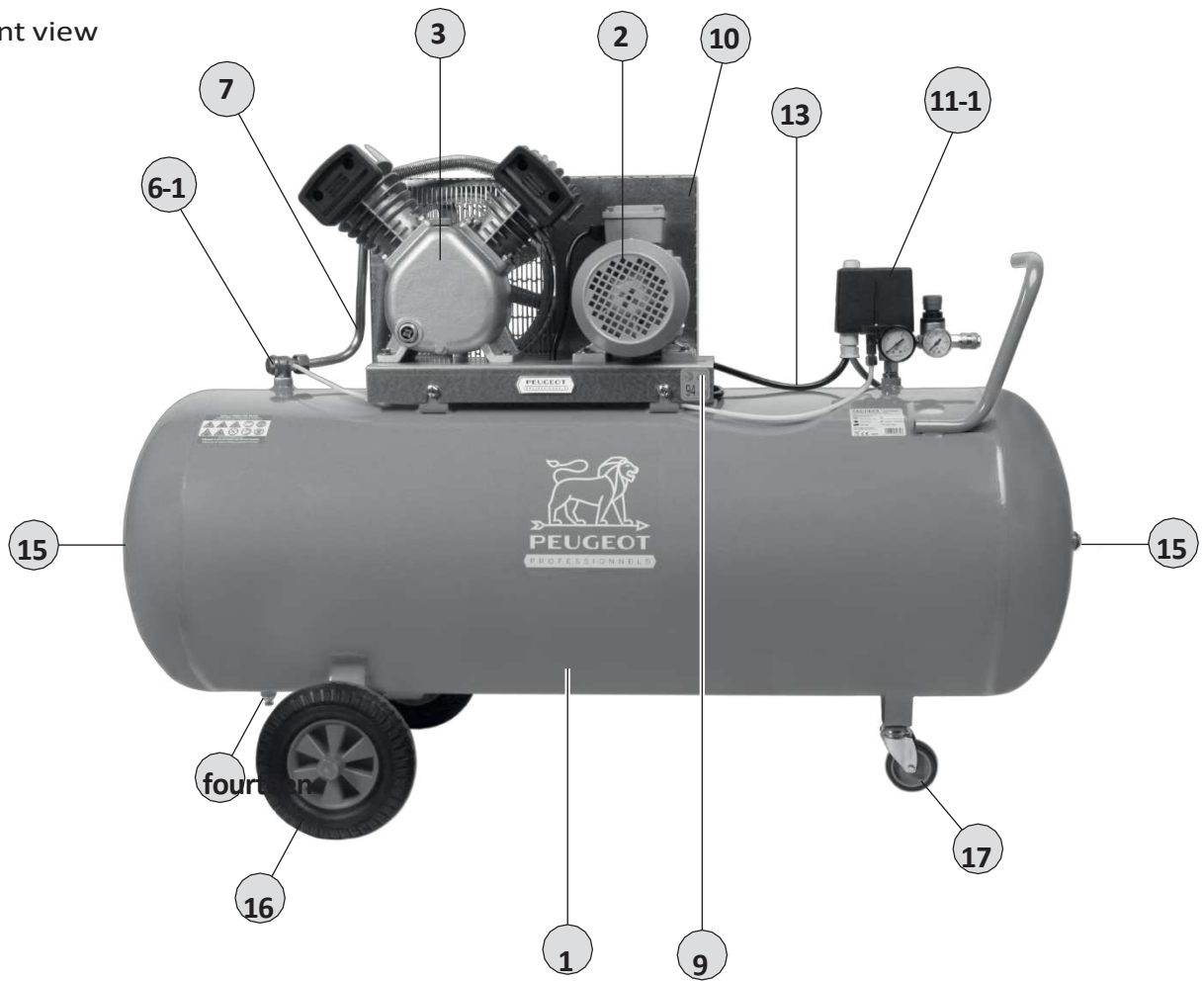

Top view



# PCAP200VT25

Marker	Designation	Quantity	Reference
1	<b>Tank</b> 200-liter bucket with handle	1	Contact us
2	<b>Group</b> Group 25 V NV	1	26 130 021
3	<b>Motor</b> 3 HP 2.2 kW Three-Phase Motor	1	26 151 020
4	Aluminum pulley 1A 125 x 24 (NR*)	1	26 210 280
5	Belt A 44 (NR*)	1	27 230 200
6	<b>Check valve</b> Check valve		
6-1	1/2 M Valve nut Ø 14	1	25 330 138
6-2		1	25 330 302
7	Annealed copper tube 12 x 14, length 0.40 m	1	26 631 030
8	<b>Evacuation tube</b> , length 0.30 m	1	28 632 120
9	<b>Galvanized plate</b> 100/150 Liter Tray	1	56 162 016
10	<b>Galvanized protective cover</b> Monobloc sump 100/150 liters	1	56 162 230
11	<b>Three-phase manifold</b>		76,220,084
11-1	Condor 6.3A circuit breaker switch, 16	1	26,310,200
11-2	bar pressure gauge, 1/4" axial, CE 10	1	26,320,520
11-3	bar safety valve, 1/4" M pressure	1	26,332,030
11-4	regulator, micron filter	1	39,514,150
11-5	1/4" MM Barb (NR*)	1	26 360 100
11-6	1/4"M - 3/8"F Reducer	1	27,362,120
12	Thread 3/8 M - 1/2 M (NR*)	1	25 360 120
13	<b>Power cord</b> 4 x 1.5 mm <sup>2</sup> , length 2 m	1	76 244 430
14	<b>Bleed valve</b> 3/8 M (NR*)	1	25 351 020
15	<b>Cap</b> 1/2 M	2	27,373,020
16	<b>Wheels</b> Wheel kit Ø 220 mm + axles	2	23 220 002
17	<b>50 L swivel wheel</b>	1	26 220 050
18	<b>High-capacity coupler 1/2M</b>	1	29,381,425

\* NR: Not represented.

# DESCRIPTION: Group 25 V

## Engine Design:

Cast iron V-twin, single-stage, 25 V engine.

Long-life components:

- Cast iron block
- Double plate valve: high-performance valves
- Triple-seal design
- Cast iron cylinders
- Aluminum cylinder

heads 2 air filters

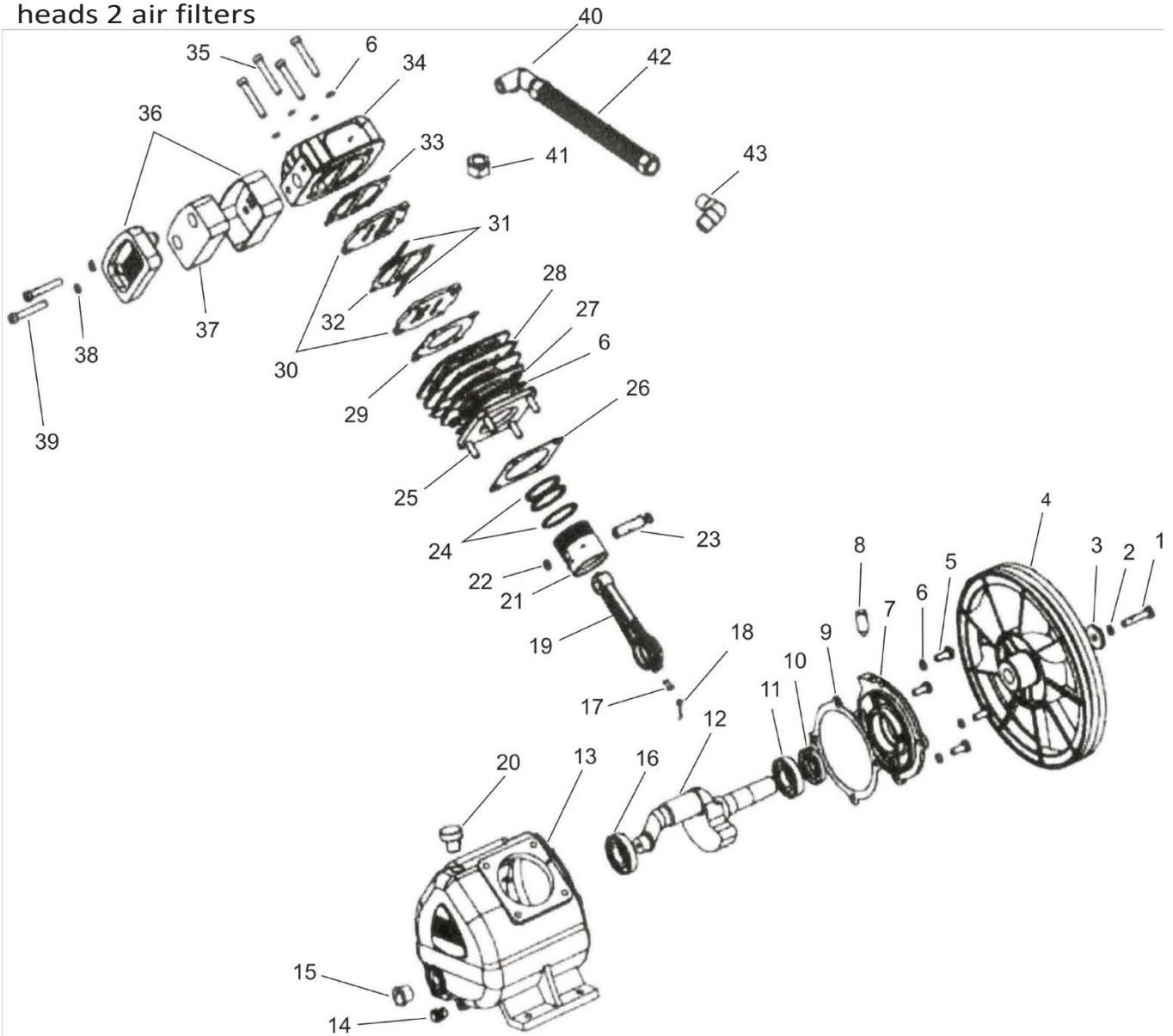

### HOW TO ORDER:

Indicate the exact reference of the group, then the part number to be ordered.  
Example: to order the cylinder head rep. 34 Cylinder Head 25 V 34

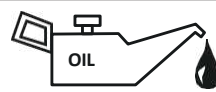

Approximate crankcase capacity: 0.36 liters

Oil level indicator



Visible oil level to be maintained when vehicle is stationary

Recommended oil: ISO VG 100

## DESCRIPTION: 25 V Group

Reference	Designation	Quantity	Reference
1	Steering wheel mounting bolt	1	
2	Brake washer	1	
3	Flat washer Ø 38	1	
4	Steering Wheel Ø 266 A1	1	26 149 912
5	Large flange fastening screw	4	
6	Brake washer Ø 8	20	
7	Large flask	1	27 149 730
8	Reniflard	1	26 149 246
9	Large joint flask	1	26 148 180
10	Joint spi Ø 24 x 47 x 8	1	26 148 580
11	Ball bearing	1	26 149 542
12	Crankshaft	1	26,140,650
13	Carter	1	
14	Drain plug	1	
15	Oil level indicator	1	26 149 212
16	Ball bearing	1	26 149 544
17	Brew kettle fixing screw	1	
18	Wick pot	2	
19	Pansies	2	26 140 102
20	Fill Cap	1	26 149 242
21	Piston only	2	26 143 122
22	Circlip piston	4	
23	Axle piston	2	
24	Game of segments	2	26 144 122
25	M8 x 35 cylinder pin	8	
26	Cylinder-crankcase seal	1	26 148 242
27	M8 nut	8	
28	Cylinder	2	
29	Cylinder-head joint	2	26 148 257
30	Valve plate bare	2 x 2	26 141 186
31	Flap	2 x 2	
32	Aluminum joint	2	26 148 312
33	Valve-to-cylinder head joint	2	26 148 006
34	Cylinder head	2	26 149 308
35	Cylinder head view	8	
36	Complete air filter	2	26,142,114
37	Air Filter Cartridge	2	26 142 322
38	Copper washer Ø 8	4	
39	Air Filter Screw HC M8 x 30	4	
40	Outlet T-fitting	1	26 149 820
41	Output nut	3	
42	Complete radiator	1	26 149 042
43	Exit elbow	1	26,149,810



## IMPORTANT PRELIMINARY INFORMATION

The legal and contractual warranty of Peugeot Professional Tools is contingent upon strict compliance with this user manual.



Before using any pneumatic tool, make sure your compressor is powerful enough for the job. Using tools that consume more than 50% of your compressor's air output capacity will cause premature wear.

Like any pressure equipment, a compressor must be used with caution, strictly following all instructions for start-up, operation, and maintenance, as well as the safety guidelines and warnings contained in this manual. Careful reading of this manual is essential **before** assembly and installation, use, maintenance, and in the event of minor malfunctions. **Carefully retain this manual** for so that you can refer to it at all times. By identifying potentially dangerous situations in a timely manner and observing the appropriate safety instructions, the risk of an accident is significantly reduced.

**Frequent purging of the tank, in particular, is essential** to limit corrosion of the tank that could weaken it. This equipment is intended for air compression only, and **for no other gas or fluid**. Never use the compressor in any way other than that specifically recommended, unless you have first ensured that the intended use will be neither dangerous to yourself nor to others.



Modifying the compressor's design or performing any work on the compressor beyond the operations authorized in this manual is prohibited. In these cases, intervention by authorized Peugeot Professional Tools service centers is required.



Points de collecte sur [www.quefairedemesdechets.fr](http://www.quefairedemesdechets.fr)  
Privilégiez la réparation ou le don de votre appareil !

This product must be recycled separately from other waste. At the end of the device's life, take it to Eco-Systèmes approved centers (landfill, etc.) for recycling the materials it's made of. It is therefore your responsibility to recycle this electronic equipment waste by handing it over to a designated collection point for electrical and electronic equipment recycling. Separate collection and recycling of your equipment waste at the time of its disposal helps protect natural resources and ensures recycling in a way that protects human health and the environment. For more information on recycling points for your equipment waste, please contact your city's recycling service or the retailer where you originally purchased the product.

Collection point at [www.quefairedemesdechets.fr](http://www.quefairedemesdechets.fr)



## RECEPTION - INSTALLATION

### Installation:

The compressor must be placed on a stable support to limit vibrations and prevent the risk of falling: **avoid a rigid floor mounting**, which would prevent the vibration from dissipating and could cause damage. The compressor does not have an anchoring point for lifting. The compressor must be unpalletized using slings positioned under the tank.

Appropriate "gripsol" skates are provided for palletized compressors without wheels.

**On wheels:** Position the compressor on a flat, stable surface.

### Start-up:

Our compressors are individually tested at the factory and leave our workshops with the tank empty.

**Before the first start-up** and any electrical connection, completely purge it by depressurizing and then draining the tank.

**Depressurization:** Ensure the compressor is stopped and the pressure switch button is in the off position, or the compressor is unplugged from the power source.

**Compressor equipped with a regulator:** Connect the air-powered tool to the compressor via an air hose. Open the regulator and operate the tool to gradually bleed off the air.

**Drainage:** Unscrew the purge valve located under the tank.

Collect the condensate, avoiding its release into the environment. Ensure it is treated, recycled, or disposed of by the competent authority. Tightly re-secure the nut after the operation.



Always make sure the tank is empty before unscrewing the drain valve. Never attempt to unscrew it if the tank is still under pressure.

The high-pressure air stream can be dangerous: never position yourself in its path. Never direct the stream at a person or animal.

Always connect the compressor to an air-consuming tool before use to prevent any uncontrolled air release.

### Oil level:

Check the oil level. If it's insufficient, top it up to the top of the red indicator and ensure the compressor is installed in a horizontal position for proper lubrication.

Use ISO VG 100 compressor oil.

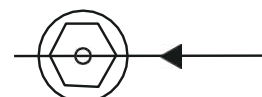



### Electrical connection:

**Caution:** This device is electrical and operates under voltage. Any work on the system (pressure switch, circuit breaker, motor, and cord) must be performed **with the power turned off.**

Disconnecting power means:

- 1) push down the Start/Stop button of the contactor **and**
- 2) unplug the power cord (or open the circuit breaker).

The compressor must be plugged into an installation with an earth connection and differential protection (against short circuits) as close as possible to the compressor's outlet so that this protection is effective.

Ensure these conditions are met and verify that the contactor button is fully depressed in the stop position before proceeding with the electrical connection.

### Overcurrent protection:

Three-phase compressor:

Due to the existence of multiple standards for three-phase installations, three-phase compressors are supplied without an electrical outlet.

Your compressor is equipped with an electric motor and appropriate overcurrent protection, with **factory settings that must not be changed** except when adapting a 400 V three-phase compressor to 230 V (see below).

**Attention:** it is not possible to operate them on a 230-volt single-phase installation.

The power cord has three conductors for the mains and one for the ground. Connect these wires to a male power plug that is suitable for your type of installation.

The earth conductor is yellow and green and must be connected to the earth terminal of the power outlet.

For proper cooling, the compressor flywheel must rotate in the direction indicated by the arrow on the protective housing. To reverse the rotation direction (if it proves incorrect), swap two of the three phase wires at the power inlet.

**Caution:** an electrical protection unit replacement is necessary (see the aforementioned explanatory manual). Contact an authorized service center.



**Power Cord - Extension Cord:**

Keep the cord out of the way of foot traffic or crushing, away from heat sources or surfaces exceeding 70°C, and away from sharp surfaces. Clean thoroughly if it comes into contact with grease or oil, as these can alter the properties of the sheath. Do not leave the cord in an acidic or corrosive environment (e.g., animal droppings).

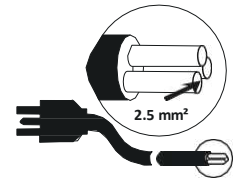

Extension cord

If the use of an electrical extension cord (less than 20 m in length) is necessary, only use standard electrical cables with a cross-sectional area of at least 2.5 mm<sup>2</sup> to prevent overheating or voltage drop in the extension cord. To correctly choose the cable's cross-sectional area, please refer to the table below.

Motor Power	Three-Phase Section
2.2 kW/3 HP	2.5 mm <sup>2</sup>
3 kW/4 HP	2.5 mm <sup>2</sup>
4 kW/5.5 HP	2.5 mm <sup>2</sup>
5.5 kW/7.5 hp	2.5 mm <sup>2</sup>
7.5 kW/10 HP	2.5 mm <sup>2</sup>
9 kW/12 HP	6 mm <sup>2</sup>

Always fully unspool the extension cord. In general, it is better to have a longer compressed air hose (25 or 50 m) than an extension cord-based setup.

Always turn off your compressor with the switch (by pushing it down) and only then unplug it, without pulling the cord sharply.

**Pneumatic connections:**

Always use compressed air hoses or flex hoses with pressure ratings suitable for the compressor (at least 50% higher than the compressor's maximum pressure).

Never use the compressor without it being connected to a tool or its intended system to prevent an uncontrolled air release.



## OPERATION

- Never use the compressor for purposes other than those specified by your dealer at the time of purchase.
- Specific applications may require compliance with standards that it is your responsibility to know and follow (inflation, washing with detergents, painting, etc.). In particular, do not use the compressor with any fluid other than compressed air.
- Regardless of the type of compressor used, the expelled air cannot be completely pure.
- If your system and/or your application requires a higher degree of purity, be sure to install the appropriate filtering devices, available from your dealer. In particular, compressed air produced by this device is not suitable for medical, food, or respiratory use.
- Never direct the jet at a person or animal. Do not allow the compressor to be operated by persons not trained in the use of the Peugeot Outils Professionnels compressor, especially children. Keep them away from the work area while working with the compressor.
- Do not use the compressor with bare feet and/or wet feet, or with wet hands.
- Never operate the compressor without the flywheel-belt protective cover properly secured and without the protective covers for the pressure switch or the circuit breaker switch closed.

### Start - Stop:

To start the compressor, plug in the power cord (or close the circuit breaker), then set the white knob of the pressure switch (or circuit breaker switch) to the ON position: "I" Auto (Vertical).

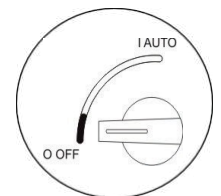

Switchacteur

When the compressor starts, the tank gradually fills with air and the pressure rises. When it reaches the stop pressure (factory-set between 8 and 9 bar) the pressure switch automatically stops the compressor.

When air is being used, the pressure in the tank drops to the restart pressure (factory-set between 5 and 6 bar). When this pressure is reached, the pressure switch automatically commands the compressor to restart.



To stop the compressor (at any time), set the white knob on the pressure switch to the OFF position: "O" (horizontal). For a power outage or extended shutdown, be sure to unplug the power cord (or open the circuit breaker).

Any intervention on the compressor requires disconnecting the power cord (or opening the circuit breaker). Set the switch to the OFF position and disconnect the power cord:

- to protect it against surges in case of a "lightning strike"!
- if you want to avoid unwanted restarts a few hours later, when the tank pressure has dropped...
- in case of prolonged disuse.

**Initial start-ups and break-in:**

The units undergo testing and a pre-break-in period at the factory.

The compressor continues its break-in period for approximately 15 hours of operation, without any specific user intervention.

Drain and replace with new oil.

**Tool Adaptation – Work Pressure Adjustment:**

To operate an accessory, you need a constant working pressure (indicated on the tool's instruction manual).

You must set the compressor's outlet pressure to the same level. The adjustment is made at the regulator.

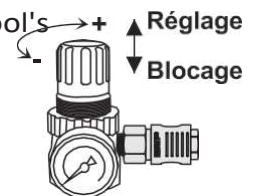

**Regulator**

Unlock the pressure regulator cap by pulling it up, then turn it clockwise to increase the pressure and counter-clockwise to decrease it.

Check the pressure on the pressure gauge. When the desired pressure is reached, lock the knob by pushing it down; this prevents it from being accidentally adjusted by vibration.

**Note:** Ensure that the regulator's set pressure is always lower than the pressure at which the pressure-switch contactor restarts. Otherwise, you will not achieve the desired pressure.

Do not use a tool whose air consumption exceeds the compressor's maximum output flow by more than 50%. Doing so would cause premature wear of the compressor.

**Note: If the compressor is not equipped as standard, you have the option to add one. Contact an authorized service center.**



**Noise precautions:**

The compressor is a noisy device. Use hearing protection to prevent any hearing damage. The acoustic power of this device is indicated on page 3. It is your responsibility to comply with the noise levels tolerated at the compressor's point of use.



**Eye precautions:**

Air and particle projections can be dangerous to the eyes. Wearing protective goggles is essential for safe use. Never point tools, hoses, etc., toward a person or an animal.



**Burn hazard:**

Certain parts of your compressor, especially the cylinders, cooling fins, discharge tube, its copper extension, and the check valve, can reach temperatures where skin contact can cause burns. Be sure not to touch them until they have cooled down sufficiently. Do not leave flammable materials or nylon fabrics near or in contact with the compressor.

## MAINTENANCE

**Attention:** Strict adherence to maintenance procedures will keep your compressor in good working order. Proper maintenance is also essential for safety, especially regular and frequent purging of the tank.

For your safety, any movement of the compressor or any maintenance operation must be performed with the compressor shut down, without a power source, and the tank emptied. The compressor should be moved on its wheels using the designated handle.



## Tank Drain:

Condensation in the tank is inherent to the normal operation of the compressor. **It is therefore essential to purge the tank as frequently as possible, and at least once a week, to prevent corrosion.** In the event of severe corrosion, the tank could crack under pressure and endanger people and property. Purge is performed by depressurizing the tank and draining any condensate that may be present.

**Strictly follow the depressurization and drainage instructions described on page 9 (installation).**

**Periodically**, after draining and before re-tightening the nut, **check that the purge system is in good working order:** start the compressor and make sure air is coming out through the purge screw (nut). Then, turn off the unit and close the screw before putting the compressor back under pressure.

Your tank complies with current regulations. Never perform any work on it, in any way (welding, etc.). If the tank is damaged, have its condition inspected by a professional.



In accordance with current French regulations, the compressor's tank must be inspected by a control body (APAVE, Véritas, etc.) every 4 years at a maximum, and requalified (pressure resistance test) by such a body every 10 years.

Condensate treatment: Do not discharge into the environment the condensates that have formed from water and oil. They must be collected by a treatment facility.

## Drain:

- It is strongly recommended to regularly check the oil level.
- Use ISO VG 100 compressor oil. Do not fill the reservoir above the top of the red level: this would cause an excessive oil supply to the system.
- Perform the first oil change as soon as the break-in period (15 hours of operation) is over.
- Then drain and rinse the crankcase every year or every 150 hours of operation.
- Heavy use of the compressor may lead to excessive oil consumption; in this case, check the oil level regularly. It is recommended to avoid mixing oils.



### To drain the unit

Using a flathead wrench, unscrew and remove the drain plug at the bottom of the crankcase. Tilt the compressor forward and let the used oil drain.

Once the used oil has been drained from the crankcase, check the condition of the drain plug seal, then reinstall the drain plug (tighten it securely).

For the amount of oil for the crankcase, refer to the group's exploded diagram.

Unscrew the filler cap, slowly pour in the oil, and adjust the amount to reach the correct oil level at the center of the indicator.

Replace the filler cap.

### Air Filters:

A clogged filter reduces the unit's performance. Clean the air filter cartridge frequently with a blower (always blow from the inside out), at least every 50 hours.

Do not use flammable products for cleaning. If it is too dirty, replace the filter.

### Safety valve:

Do not touch the safety valve. Its adjustment and operation must not be altered. Ensure it functions correctly in accordance with the specific instructions provided with the compressor.

### Valves:

Compressor operating problems often stem from particles that block the check valves of the "valve plates" located in the compressor head and/or the check valve mounted on the tank. These valves are easily accessible, and a simple cleaning will ensure the compressor operates properly. Contact an authorized service center.



The anti-return valve must be removed with the tank empty.

### Risks related to freezing:

If the compressor has been exposed to freezing, store it for a while in a temperate location or heat the pipes to melt any ice that may have formed from condensation water. Drain the tank every evening and restart in the morning with an empty tank.



## POSSIBLE CAUSES OF MALFUNCTION

### The compressor will not start:

- The tank is full.
- The pushbutton switch is not set to ON and/or the compressor is not plugged in.
- Voltage too low at the motor terminals: extension cord is too long or the EDF grid voltage is insufficient.
- The thermal cutout switch is set too low: consult Peugeot Professional Tools Customer Service.

### The unit "grumbles" but won't start:

The EDF network voltage is too low.

- Three-phase compressor: the unit is powered by two phases instead of three. Check whether the power supply circuits are adequate: contact Peugeot Professional Tools customer service.

### Insufficient flow:

All of the following interventions require performing operations off-energy, cold, and with the tank empty.

- Leak on the piping connecting the unit to the tank: loosen the pipe nuts without removing the pipe, reposition the pipe, and tighten the nuts securely.
- Loose, slipping belt: after disconnecting the compressor from the power supply, remove the cover protecting the belt and pulley, remove the belt, unscrew the motor from its mounting plate, move the motor away from the assembly by a few millimeters, tighten the motor back onto its plate, and reinstall the belt. Be sure to reinstall the protective cover before restarting.
- Clogged filter: blow it out or replace it.
- Compressor head valves clogged or worn: dismantle the head (cylinder head + valve plate) and clean or replace the valves.

**Attention:** Any disassembly of the head requires replacing the gaskets.

- Continuous leak at the switch when the compressor stops: the check valve is damaged: clean or replace the special rubber disc after unscrewing the check valve head.

**Caution:** Always disconnect the compressor from the power source and drain the tank beforehand to prevent any accidents!



### Oil is leaking:

- Worn or damaged segments. Contact Peugeot Professional Tools Customer Service.
- Cylinder damaged. Contact Peugeot Professional Tools Customer Service.
- At the cylinder heads: replace the cylinder head gaskets according to the procedure.

### Compressor assembly seized:

- Damaged connecting rod bearings: contact Peugeot Professional Tools Customer Service.
- Cylinder and piston rings damaged: contact Peugeot Professional Tools Customer Service.
- Connecting rod stuck on the crankshaft: contact Peugeot Professional Tools Customer Service.
- Damaged cylinders and segments, as well as a seized connecting rod, are generally the result of an oil shortage.

### Excess water in the expelled air:

This condensation is normal and is due to the expansion of compressed air. If your application requires expelling particularly dry air, we recommend purchasing an air dryer (contact your dealer).



**Caution:** Any other operation requires the intervention of authorized Peugeot Outils Professionnels service centers. Service performed outside this framework and without new Peugeot Outils Professionnels parts will void the product warranty.

### When your compressor trips the circuit breaker:

- Turn off the compressor at the switch.
- Wait for it to cool down before restarting it.
- After a few minutes, press the reset button on the circuit breaker located on the switch housing.
- Then restart the compressor using the switch. If it trips several times in a row, contact an authorized service center.

If you use an extension cord, make sure the cable cross-section is sufficient.

Recommended extension cord: 4 x 2.5 mm<sup>2</sup>, maximum length 20 m.



## Warranty

In the event of a warranty claim for the machine, it must be handled exclusively by an authorized after-sales service.

The machine's warranty is valid for 2 years from the date of purchase by the user. This product benefits from an additional 2-year warranty extension, provided that the user registers the product on the PEUGEOT OUTILS PROFESSIONNELS website ([www.peugeot.outils-pro.com](http://www.peugeot.outils-pro.com)) within 30 days of the date of purchase. This warranty extension is subject to the same conditions as the original warranty.

Accessories and consumables are not covered by the warranty.

It is important to keep the invoice, which serves as the warranty certificate.

The warranty is limited to the free repair or replacement of defective parts, after an evaluation by the manufacturer.

For any requests for information or spare parts regarding the machine, it is mandatory to provide the exact information from the nameplate.

The warranty does not cover damage caused by the user or by a repairer not authorized by Tivoly.

[Link to the General Warranty Conditions](#)





## CE DECLARATION OF CONFORMITY "ORIGINAL"

The undersigned (Manufacturer/Importer):

TIVOLY  
266 ROUTE PORTES DE TARENTEISE 73790 TOURS-EN-SAVOIE

Declares that the following new machine:

Designation: PISTON COMPRESSOR Brand:  
PEUGEOT OUTILS PROFESSIONNELS Model:  
PCAP200VT25  
Reference: PPC00100004  
Serial Number:

Is compliant with the applicable harmonized legislation:

NF EN ISO 12100 Machinery safety - General principles of design - Risk assessment and risk reduction (November 2010),  
NF EN 1012-1 Vacuum pumps and compressors: Safety requirements (December 2010).

It complies with the applicable essential safety requirements:

Machinery Directive (2006/42/EC),  
Low Voltage Directive (2014/35/EU)  
Simple Pressure Vessel Directive (2014/29/EU), Electromagnetic  
Compatibility Directive (2014/30/EU), Outdoor Acoustics  
Directive (2000/14/EC),  
Ecodesign Directive 640/2009, ROHS2  
2011/65/EU

Made in TOURS-EN-SAVOIE  
June 5, 2025

Stéphane Le  
Mounier, General  
Manager

	TIVOLY - Corporate Headquarters 266 ROUTE PORTES DE TARANTAISE 73790 TOURS-EN-SAVOIE	USER SERVICE Tel +33(0)4 79 89 59 00
	In its constant effort to improve the quality of its products, TIVOLY reserves the right to modify their characteristics. The information, photos, exploded views, and diagrams contained in this document are not contractual.	April 2026 Edition